



Basel Precision Instruments

BASEL PRECISION INSTRUMENTS GMBH  
c/o University of Basel, Physics Department  
Klingelbergstr. 82, 4056 Basel, Switzerland  
www.baspi.ch; info@baspi.ch

# LOW NOISE / LOW DRIFT DIFFERENTIAL AMPLIFIER SP 1'004

DATASHEET VERSION 2.1 (FROM SERIAL NUMBER 022)

JUNE 2018

## FEATURES

- DC...1 MHz differential voltage amplifier
- Low input voltage noise  
→ Typical input referred voltage noise:  
6.5 nV/sqrt(Hz) @ 1 Hz  
1.8 nV/sqrt(Hz) @ 10 Hz  
1.0 nV/sqrt(Hz) @ f >1 kHz
- Stable and low drift input voltage  
→ Typical input voltage drift @25°C:  
0.3  $\mu$ V/K
- Three decades of gain: x100, x1'000, 10'000
- Integrated low-pass-filter: 100 Hz... 1 MHz (9-steps)
- Input coupling: DC / AC (0.03 Hz)
- $\pm 1$  V common mode input voltage
- High common-mode rejection ratio:  $\geq 100$  dB @100 Hz
- Selectable input resistor: 10 Mega Ohm / 1 Giga Ohm /  $\infty$  Ohm (DC-only)
- Green LED indicates when input offset voltage is compensated and stable
- Red LED indicates overloaded condition
- SMA input & output connectors / BNC-adapters included
- Remote controllable gain and LP-cutoff
- Remote readout status: Overloaded, Offset Compensated
- Small size, low weight, low power

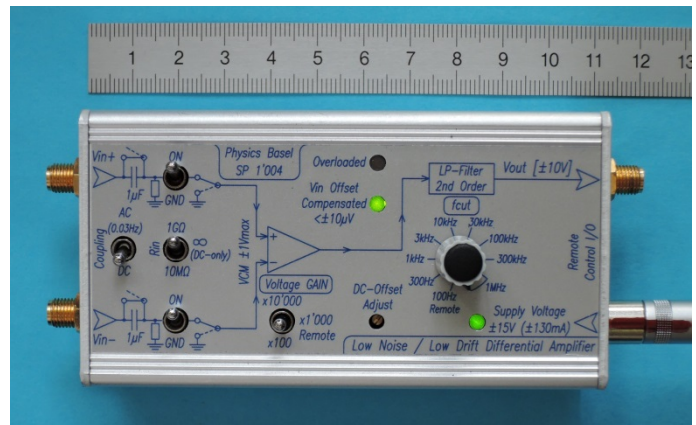

## APPLICATIONS

- Low noise voltage measurements on sensitive samples at cryogenic temperatures
- Low Drift DC differential voltage measurement
- Precise DC and AC current measurement by using a shunt-resistor
- General purpose AC / DC low noise laboratory preamplifier

## Overview

This *Low Noise / Low Drift Differential Amplifier (LNLD Diff Amp)* combines low input voltage noise with low drift in DC offset voltage. Low input voltage noise is reached by using a discrete dual J-FET (IF 3602) in the input stage with a fixed gain of x100. The offset voltage drift of this low noise J-FET input stage is reduced by a precise input offset voltage correction circuit. The input stage is followed by switchable gain block (x1, x10, x100) and a variable LP-Filter. The block diagram of the *LNLD Diff Amp* is shown below:

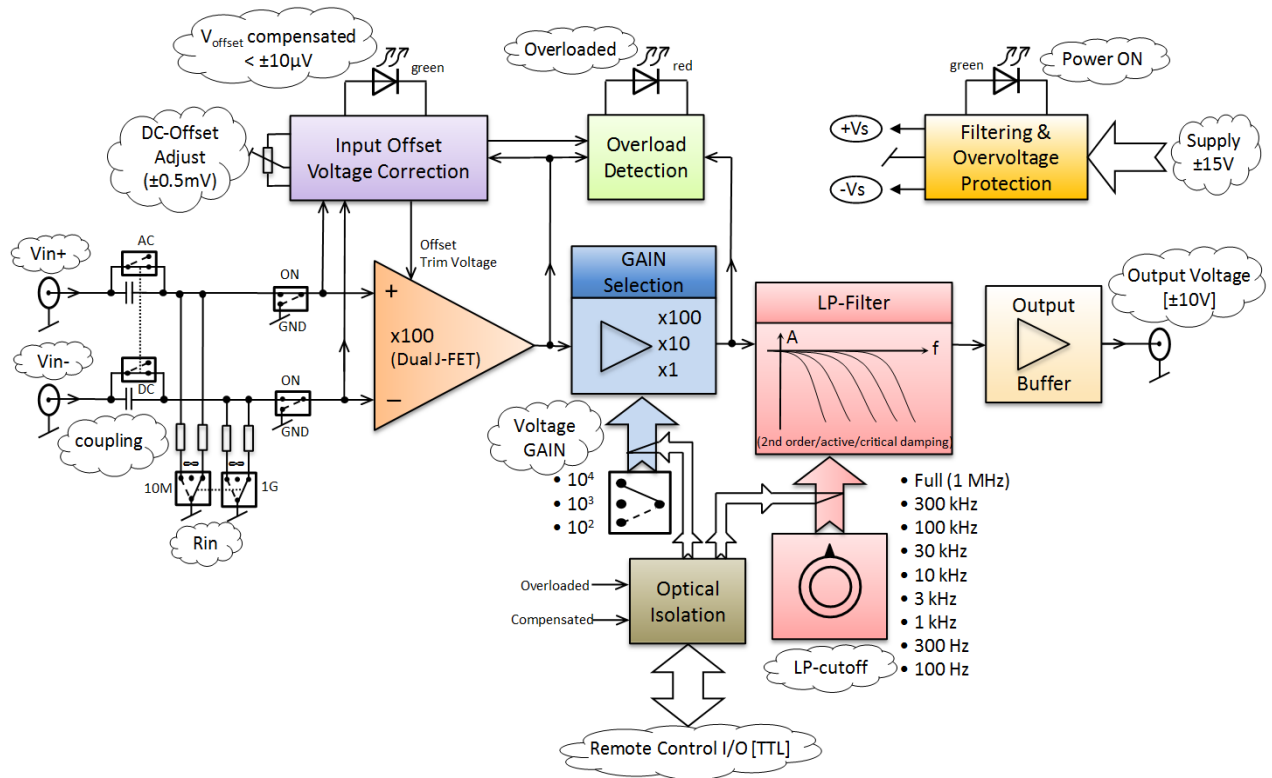

The light weight and small housing of the *LNLD Diff Amp* permits the installation of this device directly onto the breakout box of the cryostat, or very close to it. Doing so, the cumbersome and sensitive cables (noise pick-up, microphonics) between the cryostat and the preamplifier can be avoided. When cables are required at the input, use low-noise coaxial cables, twist them and avoid mechanical vibrations on the cables and the preamplifier. Make sure that no ground-loop is closed over the sensitive input cables.

Since the gain as well as the low-pass cutoff frequency can be remotely controlled (e.g. by a computer) the *LNLD Diff Amp* can be installed in a not readily accessible place. The remote control signals are galvanic isolated by optocouplers and therefore they do not interfere with the sensitive input signals and no ground loop can be formed.



When using the *Remote Control Interface (SP 1'004a)* – shown on the left – the parameters can be adjusted manually (touch-screen) or via simple ASCII commands send form a computer via a serial interface (RS-232) at a baud-rate of 9'600.

For further information see the user's manual *LNLD Differential Amplifier Remote Control Interface (SP 1'004a)*.

# 1. Input Offset Voltage

To improve the stability and temperature drift of the low noise discrete dual J-FET a high-precision servo control loop cancels out the input offset voltage and its drift due to changes in ambient temperature or due to aging. At around 25°C a typical temperature drift of only 0.3  $\mu\text{V}/\text{K}$  (max. 2  $\mu\text{V}/\text{K}$ ) is reached by this circuit. This is about two decades better than the unstabilized J-FET input stage.

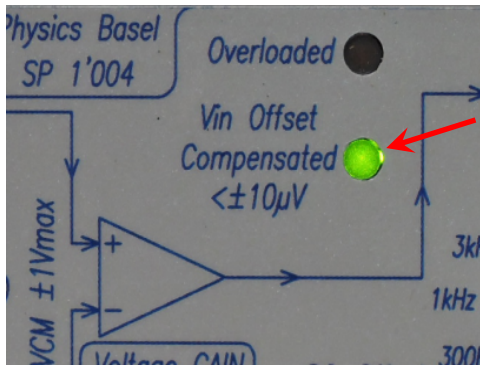

The green LED *Vin Offset Compensated* lights up when the input offset voltage gets stabilized within around  $\pm 10\mu\text{V}$  (see left). After power up the device it takes several minutes (typical 5...15 minutes) until the automatic input offset compensation is completed and the green LED is turned on. The entire warmup of the device takes around two hours.

When the offset compensation runs into its limit the red LED *Overloaded* is turned on. Under normal condition this should never happen while the ambient temperature stays in the range from +10°C to +40°C.

The input offset voltage of the preamplifier can be manually adjusted in a range of typical around  $\pm 700\mu\text{V}$  (minimum  $\pm 500\mu\text{V}$ ) by using the multi-turn trimmer *DC-Offset Adjust* (see right).

Use a small screwdriver to access the trimmer. Turning clockwise makes the output voltage more positive.

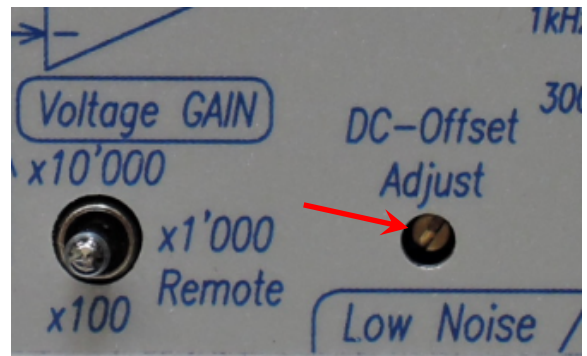

Since this offset adjustment sets the zero-voltage of the servo control loop, it reacts very slowly. Therefore perform the adjustments very gently! Make at maximum a quarter-turn and wait until the output voltage has stabilized again, before continuing the adjustment. When turning too fast, the green LED *Vin Offset Compensated* will go out.

Working in the DC- $\mu\text{V}$  region, thermoelectric voltages can cause troubles. They are generated at the junctions between different metals which are common in standard SMA/BNC-connectors. Therefore use short and good cables/connectors and wait until the setup has reached its thermal equilibrium, before starting the DC input offset adjustment.

When connecting cables to the input of the preamplifier wait a few minutes until the connectors are on the same temperature. While touching one connector at the input (*Vin+* or *Vin-*) with your fingers it gets heated-up and generates a different thermoelectric voltage with respect to the other colder connector.

## 2. Input Voltage Noise

Low input voltage noise is essential for a voltage preamplifier. The typical “white” input referred noise density of the *LNLD Diff Amp* is around 1 nV/√Hz. This corresponds to the thermal noise density of a 60 Ohm resistor at room temperature (300 K). Therefore all noise measurements are taken with the input shored to *GND* (both switches in position *GND*).

The graph below shows the measured input voltage noise density of *LNLD Diff Amp*. The 1/f-noise frequency-corner is at around 30 Hz. For frequencies above 1 kHz only the “white” noise density of around 1 nV/√Hz is present – corresponding to the thermal noise of a 60 Ohm resistor at 300K (see dashed black line).

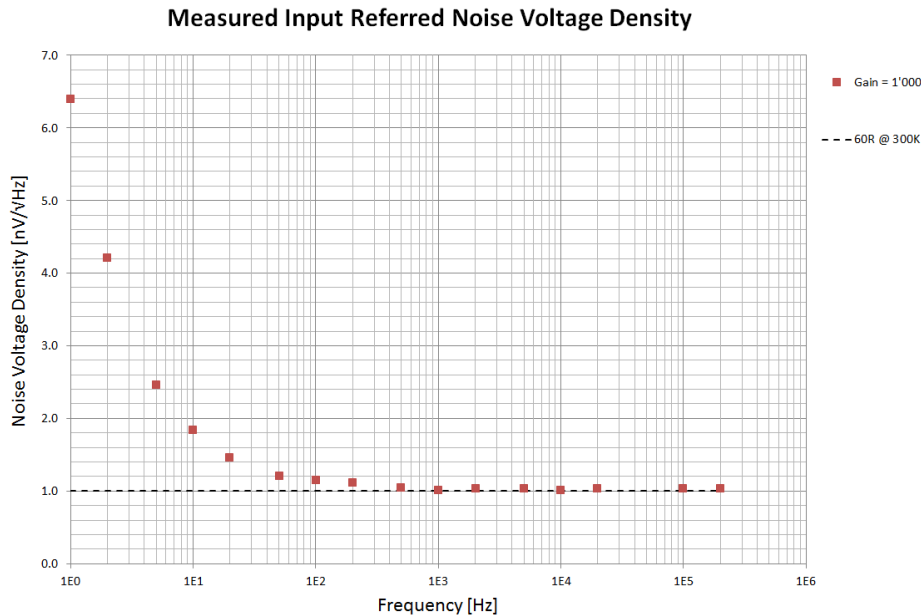

The measured integrated input noise voltage is given below; for reference also the integrated noise voltage of a 60 Ohm resistor at 300K is shown in black. The integration starts at a frequency of 0.5 Hz.

For a brick-wall bandwidth from 0.5 Hz up to 1 kHz the integrated input noise voltage is around 35 nV<sub>RMS</sub> and from 0.5 Hz up to 100 kHz around 310 nV<sub>RMS</sub>.

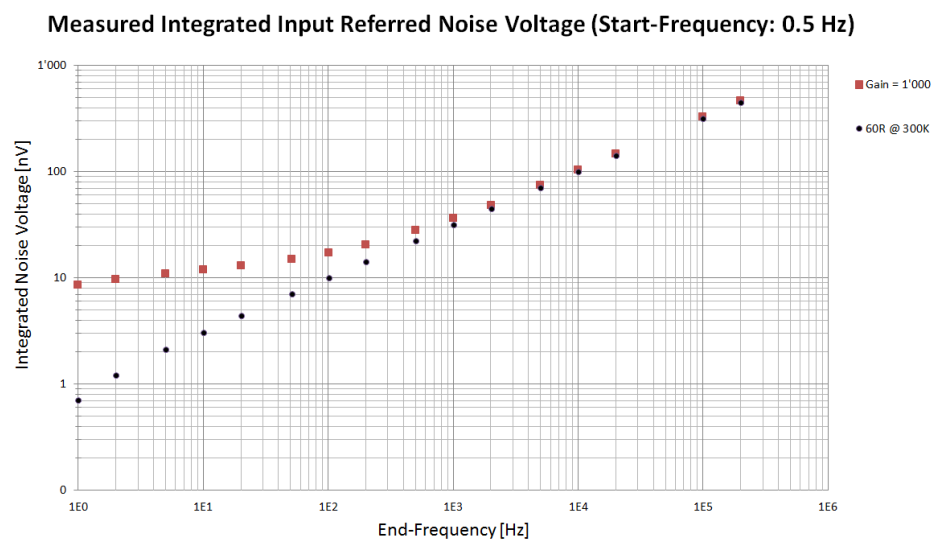

For long term DC-voltage measurements a low input voltage temperature-drift and a low input voltage noise density is necessary. Since the *LNLD Diff Amp* combines these two features it is very suitable for such measurements on samples at cryogenic temperatures near the absolute zero.

### 3. Input Current

The input current of the *LNLD Diff Amp* is coming from the gate-leakage ( $I_{leak}$ ) of the input J-FET and depends on its temperature. It gets doubled when the ambient temperature is increased by 10 K.

At an ambient temperature of 20°C the typical input leak-current is 15 pA; it increases to about 30 pA at 30°C.

### 4. Input Current Noise

The “white” input current noise density is dependent on the selected input resistance. The thermal current noise density ( $I_{noise}$ ) of a resistor is given by its value ( $R$ ) and its temperature ( $T$ ):

$$I_{noise} = \sqrt{\frac{4kT}{R}}$$

At room temperature (300 K) a 10 Mega Ohm resistor has a “white” input current noise density of 41 fA/√Hz and a 1 Giga Ohm resistor 4.1 fA/√Hz.

The “white” shot noise density ( $I_{shot}$ ), generated by the input leakage current ( $I_{leak}$ ) of the J-FET, is given by:

$$I_{shot} = \sqrt{2e_0 I_{leak}}$$

A leakage current of 30 pA (@T = 30°C) leads to “white” shot noise density of 3.1 fA/√Hz.

The thermal and the shot noise are statistically added. At T = 30°C they lead to the following theoretical input noise densities (see table below, rightmost row). The input current noise density of the *LNLD Diff Amp* is measured at the frequency of 10 Hz and 1 kHz (see table below).

Selected Input Resistance [Ohm]	Measured Input Current Noise @ 10 Hz / @30°C [fA/√(Hz)]	Measured Input Current Noise @ 1 kHz / @30°C [fA/√(Hz)]	Theoretical Input Current Noise @ 30°C [fA/√(Hz)]
∞ (DC-only)	6	12	3.1
1 Giga	7	14	5.1
10 Mega	43	48	41.1

The input current noise increases for higher frequencies due to the capacitive-coupling inside the J-FET from the drain (where some noise voltage is present) to the gate. Therefore the measured input current noise density at 1 kHz is higher than at 10 Hz.

## 5. Common-Mode Rejection Ratio (CMRR)

Signals which are common on both inputs ( $V_{in+}$  and  $V_{in-}$ ) shouldn't be amplified by a differential amplifier. The CMRR is the ratio between the differential voltage gain and the common-mode voltage gain; a high CMRR is desired. The CMRR is dependent on the frequency and drops for higher frequencies due to slightly AC-asymmetries of the differential amplifier.

Often the largest common-mode voltages are caused by the mains supply and its harmonics. In Europe (USA) the 50 Hz (60 Hz) and the 150 Hz (180 Hz) harmonics are commonly present.

The graph below shows the measured CMRR of the *LNLD Diff Amp* at a gain of x1'000 in the frequency range from 10 Hz to 100 kHz; in the frequency range from 10 Hz to 1 kHz this device shows a CMRR of around 120 dB. This measurement is performed at an ambient temperature of 25°C; the CMRR-curve varies slightly over temperature.

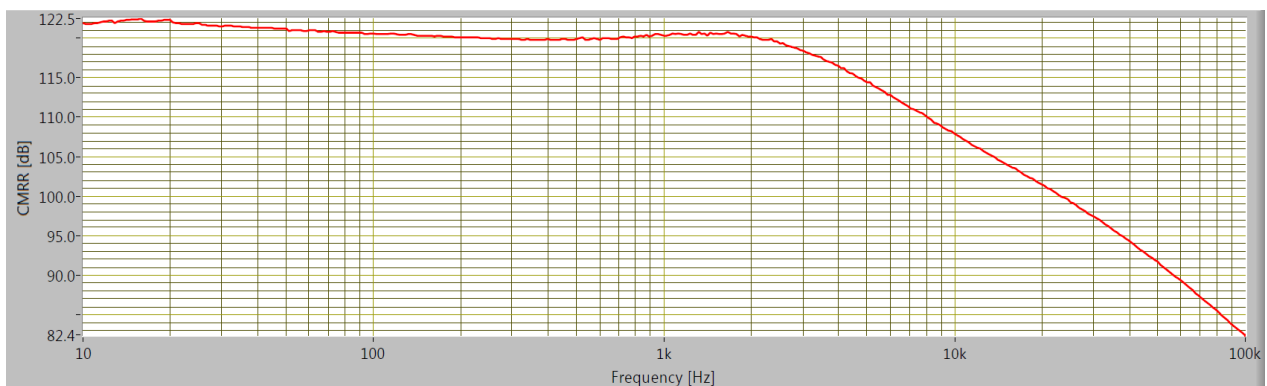

The *LNLD Diff Amp* allows a maximum common-mode voltage ( $V_{CM}$ ) of up to  $\pm 1$  V. Above this maximum common-mode range the red LED *Overloaded* is turned on.

### Example:

Differential voltage: 3 mV<sub>RMS</sub>

Common-mode Voltage: 500 mV<sub>RMS</sub> @150 Hz

Gain: x 1'000 (60 dB)

CMMR @150 Hz: 112 dB

Differential voltage: 3 mV<sub>RMS</sub> x 1'000 = 3 V<sub>RMS</sub> (**Wanted Signal**)

Common-mode voltage rejection: 112 dB – 60 dB = 52 dB → Factor 398

Common-mode voltage: 500 mV<sub>RMS</sub> / 398 = **1.26 mV<sub>RMS</sub>** (**Unwanted Signal**)

## 6. Selectors, Indicators & I/O Connectors, Size

Below the switches, the selectors, the LED indicators and the I/O connectors of the *LNL D Diff Amp* are shown:

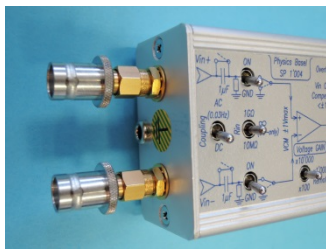
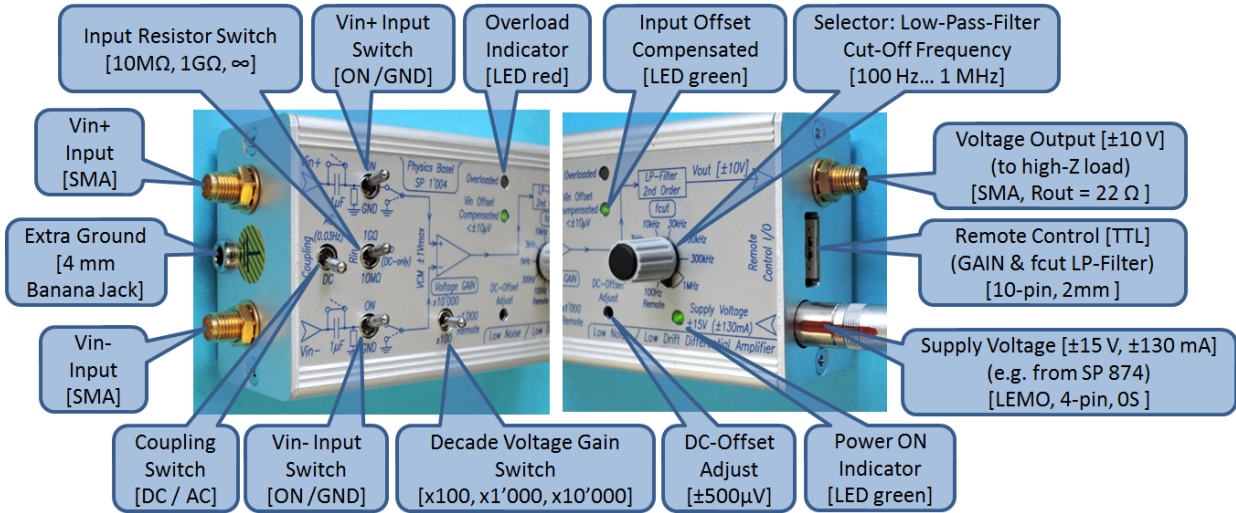

All the analog I/O signals are connected by SMA connectors to the preamplifier. If BNC connectors are preferred the stable SMA/BNC-adapters (which are included) can be screwed directly onto the *LNL D Diff Amp* (see photo on the left).

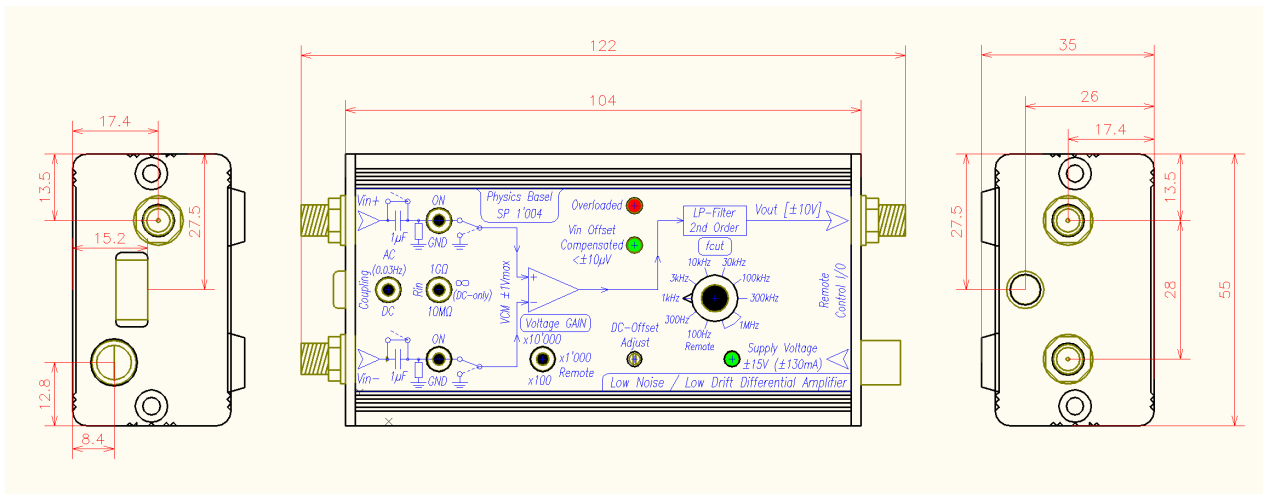

The size [mm] and position of the connectors are shown above. The weight of the device is 286 g; this allows the mounting directly onto the breakout-box of the cryostat.

## 7. Voltage Inputs, AC-/DC-Coupling

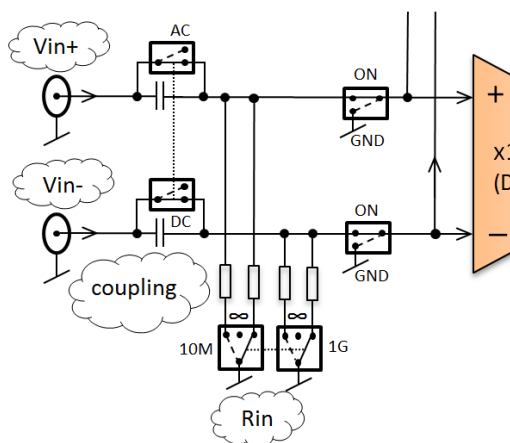

The  $Vin+$  is the NON-INVERTING voltage input while the  $Vin-$  is the INVERTING voltage input of the differential amplifier (see left).

The two inputs voltages ( $Vin+$ ,  $Vin-$ ) can be individually switched *ON* or *OFF*. When switched *OFF* the corresponding input of the differential preamplifier is tied to *GND*; therefore the switch is named *ON/GND*. Nevertheless, the input is still high-impedance.

With the  $Rin$ -switch the input resistance at  $Vin+$  and  $Vin-$  can be selected between 10 M $\Omega$ , 1 G $\Omega$  and  $\infty$ ; both inputs are switch together in parallel. At the  $Rin$ -switch position " $\infty$ " no

discrete resistor to *GND* is present; the signals are wired only to the high-impedance ( $T\Omega$ ) gate of the JFET. This high-impedance switch position " $\infty$ " can only be used when the input signals are DC-coupled; when AC-coupled the gate voltages would be undefined due to the JFET leakage input currents.

The input capacitance ( $Vin+$ ,  $Vin-$ ) to *GND* is around 25 pF and the coupling capacitance between  $Vin+$  and  $Vin-$  is around 4 pF measured at 1 kHz.

When AC-coupling is selected the high-pass cut off frequency (-3 dB) is at around 0.03 Hz, independent of the selected input resistance. AC-/DC-coupling is defined by one switch for both inputs in parallel.

DC input voltages up to  $\pm 30$  V can be blocked by using the AC-coupling mode. For faster loading the DC-blocking capacitors at the input, first select an input resistance of 10 M $\Omega$  and wait a minute before switching to 1 G $\Omega$ . To prevent the preamplifier from excessive overload or damage, switch always both inputs to *GND* while attaching/altering DC input voltages and wait a minute before switch *ON* the inputs.

The maximum input differential voltage is  $\pm 100$  mV which results in an output voltage of  $\pm 10$  V at a gain of x100. The maximum common-mode voltage ( $V_{CM}$ ) is  $\pm 1$  V independent of the selected gain.

When amplifying single-ended signals, feed them to the  $Vin+$  input (switched *ON*), while the  $Vin-$  must be switched to *GND*; so the output is the non-inverted amplified single-ended input signal.

The voltage inputs of the *LNLD Diff Amp* are protected against overvoltage. Nevertheless, be careful what you connected to these sensitive inputs. Do not touch the inner conductor of the inputs with your fingers or any objects, since electrostatic discharge (ESD) may damage the sensitive input J-FET. During manipulations at the *LNLD Diff Amp*, grounding of sensitive samples is strongly recommended!

## 8. Input Load Impedance, Oscillation

Capacitive- and resistive-loads at the input of the *LNLD Diff Amp* are non-problematic. But inductive loads larger than 1  $\mu$ H may lead to high-frequency oscillation of the amplifier. The oscillation-sensitivity is dependent in the Q-factor of the inductance and the oscillation frequency varies between 10 kHz and several MHz.

If such oscillation occurs, install a series resistor in the range of 10 Ohm ... 1 kOhm or a parallel resistor (10 kOhm ... 100 Ohm to *GND*) at the inductively-loaded input of the *LNLD Diff Amp*. By doing so the oscillation can be efficiently suppressed but the noise performance of the amplifier is slightly degraded.



## 9. Gain & Output

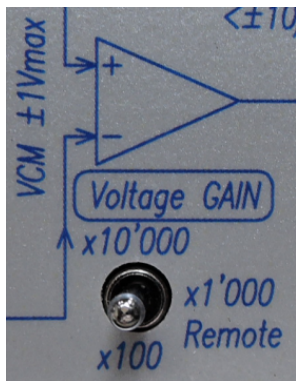

The voltage gain of the *LNLD Diff Amp* can be switched over the following three decades: x100, x1'000, x10'000 corresponding to a maximum input voltage of  $\pm 100$  mV,  $\pm 10$  mV,  $\pm 1$  mV. These ranges cover the most often used gains in cryogenic experiments. The accuracy of the voltage gain is typically better than  $\pm 1\%$  (max.  $\pm 3\%$ ).

The output voltage has an impedance of 22 Ohm and must be connected to high impedance ( $\geq 10$  k $\Omega$ ) load. The output voltage swing is linearly within a voltage of  $\pm 10$  V. The output slew-rate is 6 V/ $\mu$ s which restricts the full-swing output ( $\pm 10$  V) to a maximum frequency of 100 kHz. At a frequency of 1 MHz the sinusoidal output signal can reach a level up to 500 mV<sub>RMS</sub>.

When the output voltage of the *LNLD Diff Amp* reaches or exceeds +9.5 V or -9.5 V the red LED *Overloaded* is turned on. Note that the overload is detected on the unfiltered output voltage of preamplifier stage. While measuring AC-signals (e.g. with a lock-in) and the LP-filter set to the lower frequency range, the output voltage may still be in its linear range ( $\pm 10$  V) while an overload is detected at the unfiltered signal – that's why you should pay attention to the red LED *Overloaded* during your experiments running with AC-signals. The overload information is also available (galvanic isolated) on the *Remote Control I/O* connector and the *Remote Control Interface (SP 1'004a)* does also readout and display this warning. For remote-controlling the gain, the switch must be in center position at x1'000/*Remote*.

## 10. Low-Pass-Filter

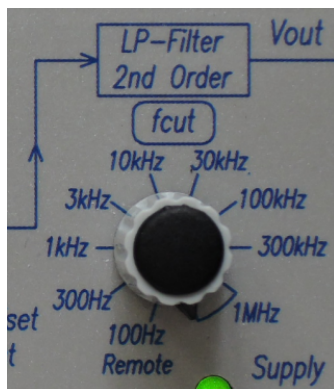

The 1 MHz maximum bandwidth of the *LNLD Diff Amp* can be reduced by the subsequent low-pass-filter (LP-filter). The cut-off frequency (-3 dB) of the LP-filter can be selected from 100 Hz up to 1 MHz within nine steps (see left). The accuracy of the cut-off frequency ( $f_{cut}$ ) is within  $\pm 20\%$ . At the two positions *1MHz* the filter is switched off and the bandwidth of the preamplifier reaches around 1 MHz. The LP-filter is 2<sup>nd</sup> order (-40 dB/decade) and is designed with a critical damping, which results in no overshoot in the time step-response. The maximum damping of this filter is limited by its design to around 65 dB. For remote-controlling the cut-off frequency, the rotary switch must be set to the position at *100Hz/Remote*.

The following plot shows the measured small-signal (500 mV<sub>RMS</sub>) frequency response with the nine different LP-filter cut-off frequencies. The 0 dB level corresponds to a gain of x1'000 (60 dB).

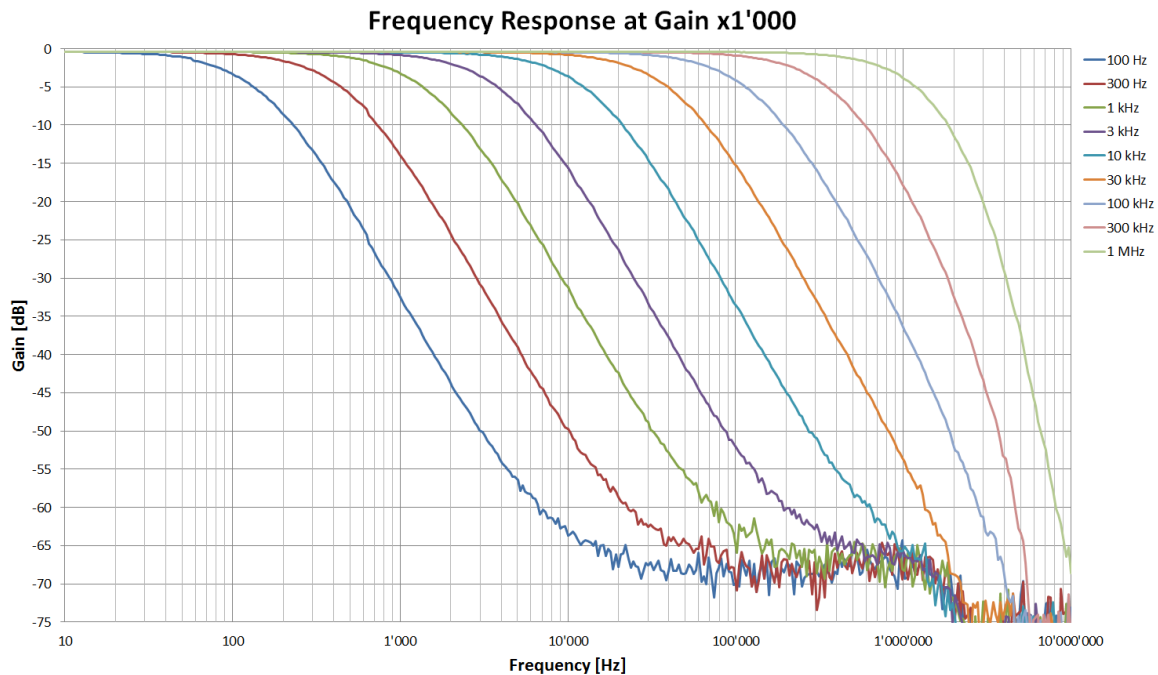

The table below shows the typical step-response rise/fall-times (10%, 90%) of the LP-filter for the different cut-off frequencies. Note that the LP-filter cut-off frequencies ( $f_{cut}$ ) have a tolerance of up to  $\pm 20\%$  and therefore also the rise/fall-times can vary up to  $\pm 20\%$ . Further note that the slew-rate of the output signal is restricted to 6 V/ $\mu$ s.

$f_{cut}$	100 Hz	300 Hz	1 kHz	3 kHz	10 kHz	30 kHz	100 kHz	300 kHz	1 MHz
tr / tf	3.44 ms	1.15 ms	344 $\mu$ s	115 $\mu$ s	34.4 $\mu$ s	11.5 $\mu$ s	3.44 $\mu$ s	1.15 $\mu$ s	344 ns

## 11. Supply Voltage

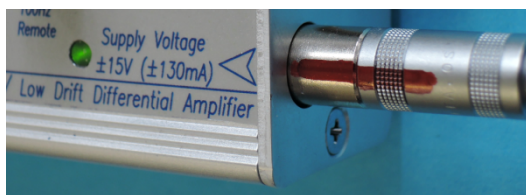

The supply voltage of the *LNL Diff Amp* is  $\pm 15$  V with a tolerance of  $\pm 5\%$ . The green LED "ON" lights up when the supply voltage reaches  $\pm 13.5$  V (see left). The typical quiescent current is around  $\pm 90$  mA, but it can rise to  $\pm 130$  mA during normal working conditions.

It is very important that the *LNL Diff Amp* is supplied by a floating, low noise, low ripple and stable voltage source.

Only when using a high-quality and low noise power supply the outstanding noise performance and the high stability input voltage can be reached. Linear regulated laboratory power supplies (e.g. *KEITHLEY 2230*), our *Floating Supply  $\pm 15$  V (SP 874)* or  $\pm 15$  V batteries/accumulators are suitable for supplying this preamplifier.

The ground (0 V) of the power supply must be floating and the earth leakage current should be less than 2  $\mu$ A<sub>RMS</sub>. Inside the *LNL Diff Amp* ground (GND, 0 V) of the power supply is connected to the housing and therefore also to the shield of the power supply socket. To prevent from noise pick-up on the long cable to the power supply, use a shielded one and connect the shield only at the socket of the *LNL Diff Amp*.

The connector for the  $\pm 15$  V supply voltage is a 4-pole *LEMO* series *05* with the following part number: *FFA.05.304.(CLAC44)*

The pin assignment of the power connector is the following:

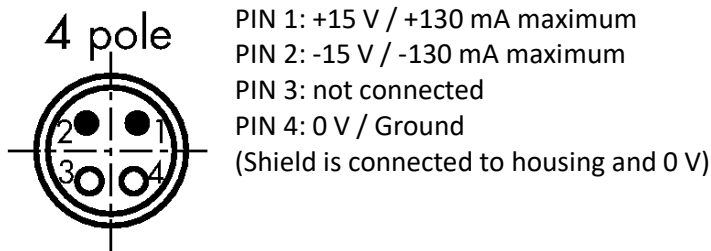

## 12. Remote Control



Via the *Remote Control I/O* connector (see left) the gain and the LP-filter cut-off frequency can be controlled by an external source (e.g. computer). The remote control signals are galvanically isolated with optocouplers from the electronics of the *LNL Diff Amp*. Therefore no ground-loops or interference can occur by using these remote control lines. Nevertheless, make sure that the TTL control signals are clean and do not carry any high-frequency noise. High-frequency noise may capacitive coupling into the sensitive electronics of the preamplifier. If this is observed, low-pass filtering of the TTL control signals, before entering the device, may be necessary.

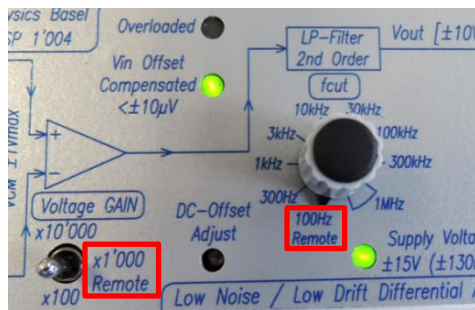

When the gain is remotely controlled the switch “Voltage GAIN” has to be in the position “x1’000, Remote”. For remote controlling the LP-filter cut-off frequency the rotary switch “fcut” must be set to the position “100Hz, Remote” (see left). It is possible to control only the gain or only the cut-off frequency remotely and manually set the other by the switch.

A 10-pole flat cable connector *Minitek 2x5P* (type *89947-710LF*) fits into the socket of the *Remote Control I/O*. In low-interference laboratory environment an unshielded flat cable up to a length of around five meters can be connected between the *LNL Diff Amp* and a computer. The assignment of the remote control connector is the following:

PIN 1	PIN 2	PIN 3	PIN 4	PIN 5	PIN 6	PIN 7	PIN 8	PIN 9	PIN 10
G0	F0	G1	F1	COM IN	F2	OVL	F3	COMP	COM OUT

G0...G1 is for the gain selection and F0...F3 for setting the LP-filter cut-off frequency. COM IN (PIN 5) is the common ground (0 V of the computer) for the gain and filter remote TTL control input signals. A logic high (1) needs a voltage larger than +2.5 V and a logic low (0) a voltage smaller than +0.8 V; the remote control inputs are therefore compatible with 3.3 V logic output levels. Each remote control input signals is loaded by a 1.8 k $\Omega$  resistor to the common input ground (COM IN). Do not apply voltages higher than +7 V and no negative voltages to these remote control inputs.

COM OUT (PIN 10) is the common ground (0 V of the computer) for the “overloaded” (OVL) and the “offset compensated” (COMP) output signals. These open-collector outputs (from optocouplers) must be externally pulled-up to +3.3 V to generate a TTL-level signal; a pull-up resistor of 10 kOhm is suggested. The logic of these two output signals are active low (0 V when “overloaded” or “offset compensated” are true).

Below the table for remote setting the gain is given:

Voltage GAIN	G1 (PIN 3)	G0 (PIN 1)
x10'000	1	0
x1'000	0	0
x100	0	1

1 = logic high >2.5 V / 0 = logic low <0.8 V (with respect to COM IN)

The typical gain-switching time is around 100 µs.

The LP-filter cut-off frequency is remote controlled by the following combinations:

LP-Filter cut-off	F3 (PIN 8)	F2 (PIN 6)	F1 (PIN 4)	F0 (PIN 2)
1 MHz	1	0	0	0
300 kHz	0	1	1	1
100 kHz	0	1	1	0
30 kHz	0	1	0	1
10 kHz	0	1	0	0
3 kHz	0	0	1	1
1 kHz	0	0	1	0
300 Hz	0	0	0	1
100 Hz	0	0	0	0

1 = logic high >2.5 V / 0 = logic low <0.8 V (with respect to COM IN)

## 13. Typical Specifications (Ambient Temperature = 25° C)

- **Warm-up time:** 2 hours
- **Environment:** In house dry laboratory conditions, no bedewing
- **Operating ambient temperature:** +10°C...+40°C
  
- **Supply voltage:** ±15 V, ±5%, floating, low noise, high stability
- **Supply current:** ±90 mA (max. ±130 mA)
- **Green LED ON turned on:** When supply voltage > ±13.5 V
  
- **Bandwidth (-3 dB):** DC...1 MHz
- **Voltage Gain:** x100 | x1'000 | x10'000
- **Gain accuracy:** ±1% (maximum ±3 %)
  
- **Input Common-Mode Voltage Range:** ±1 V
- **Input Common-Mode Rejection Ratio:** ≥100 dB @ 100 Hz
  
- **Input voltage noise [nV/sqrt(Hz)]:** 6.5 @ 1 Hz | 1.8 @ 10 Hz | 1.0 @ f > 1 kHz
- **Integrated input voltage noise from 0.5 Hz to 1 kHz:** 35 nV<sub>RMS</sub>
- **Input current (Vin+, Vin-):** ±15 pA @20 °C | ±30 pA @30 °C
- **Input current noise @Rin=∞ [fA/sqrt(Hz)]:** 6 @ 10 Hz | 12 @ 1 kHz
  
- **Input DC-Offset Temperature Drift:** 0.3 μV/K (max. 2 μV/K)
- **Input DC-Offset Voltage Adjust:** ±700 μV (manual by multi-turn trimmer) = V<sub>offset</sub>
- **Green LED Offset Compensated ON:** When input offset voltage < ±10 μV (with respect to V<sub>offset</sub>)
  
- **Output voltage swing:** min. ±10 V @ 10 kΩ
- **Output impedance:** 22 Ω
- **Output voltage slew-rate:** 6 V/μs
- **Full output voltage-swing sinusoidal frequency:** 100 kHz
  
- **LP-filter cut-off frequency:** 100 Hz, 300 Hz, 1 kHz, 3 kHz, 10 kHz, 30 kHz, 100 kHz, 300 kHz, 1 MHz
- **LP-filter cut-off frequency accuracy:** ±20%
- **LP-filter characteristics:** 2<sup>nd</sup> order, critical damping (no overshoot), 65 dB maximum damping
  
- **AC-coupling high-pass frequency (-3 dB):** 0.03 Hz
- **Maximum DC-Blocking Voltage (AC-coupling):** ±30 V
  
- **DC input resistance:** 10 MOhm | 1 GOhm | ∞ (DC-Coupling only)
- **Input capacitance (Vin+, Vin-):** 25 pF to GND | 4 pF (@1 kHz) between Vin+ and Vin-
  
- **Red LED Overloaded turned on when:**
  - Output voltage > +9.5 V or < -9.5 V
  - Common-mode input voltage > ±1 V
  - Automatic offset-compensation fails (ambient temperature out of range)
  
- **Remote control input signals:** Positive TTL, High-level > 2.5 V, Low-level <0.8 V
- **Remote control input impedance:** 1.8 kΩ
- **Remote control output signals (Overloaded, Offset Compensated):** Open-collector (Active Low)
  
- **Overall size (no adapters and no cables):** 122 mm x 55 mm x 35 mm
- **Weight (no adapters and no cables):** 286 g